



## INSTRUCTION MANUAL

# SRC-800A

---

**Video Cassette Recorder**

English

---

**Magnétoscope à Cassette**

Français

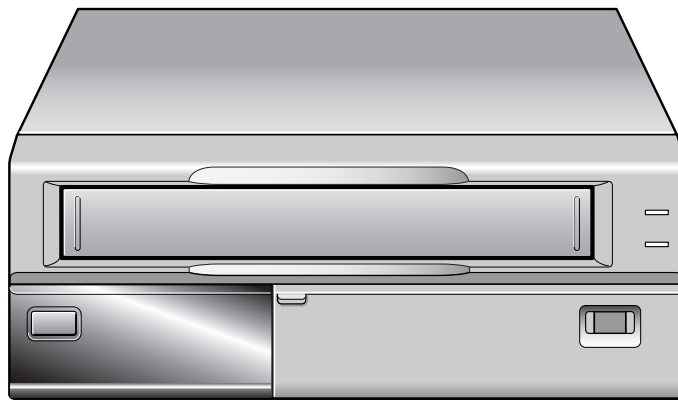

Please read this manual and accompanying "IMPORTANT SAFETY INSTRUCTIONS" sheet carefully before connecting your VCR and operating it for the first time.

Be sure to read carefully and follow all the PRECAUTIONS on page 1 and 2.

Keep the manual in a safe place for future reference.

# PRECAUTIONS



## CAUTION

RISK OF ELECTRIC SHOCK  
DO NOT OPEN



**CAUTION:** TO REDUCE THE RISK OF ELECTRIC SHOCK,  
DO NOT REMOVE COVER (OR BACK).  
NO USER-SERVICEABLE PARTS INSIDE.  
REFER SERVICING TO QUALIFIED SERVICE PERSONNEL.

**WARNING:** To reduce the risk of fire or electric shock, do not expose this appliance to rain or other moisture.

**CAUTION:** Changes or modifications not expressly approved by the manufacturer may void the user's authority to operate this equipment.

## For customers in Canada

This class B digital apparatus complies with Canadian ICES-003.



The lightning flash with arrowhead symbol, within an equilateral triangle, is intended to alert the user to the presence of uninsulated "dangerous voltage" within the product's enclosure that may be of sufficient magnitude to constitute a risk of electric shock to persons.



The exclamation point within an equilateral triangle is intended to alert the user to the presence of important operating and maintenance (servicing) instructions in the literature accompanying the product.

This equipment has been tested and found to comply with the limits for a Class B digital device, pursuant to part 15 of the FCC Rules. These limits are designed to provide reasonable protection against harmful interference in a residential installation. This equipment generated, uses and can radiate radio frequency energy and, if not installed and used in accordance with the instructions, may cause harmful interference to radio communications. However, there is no guarantee that interference will not occur in a particular installation. If this equipment does cause harmful interference radio or television reception, which can be determined by turning the equipment off and on, the user is encouraged to try to correct the interference by one or more of the following measures:

- Reorient or relocate the receiving antenna.
- Increase the separation between the equipment and receiver.
- Connect the equipment into an outlet on a circuit different from that to which the receiver is connected.
- Consult the dealer or an experienced radio/TV technician for help.

# PRECAUTIONS

## Location

For safe operation and satisfactory performance of your VCR, keep the following in mind when selecting a place for its installation:

- Shield it from direct sunlight and keep it away from sources of intense heat.
- Avoid dusty or humid places.
- Avoid places with insufficient ventilation for proper heat dissipation. Do not block the ventilation holes of the VCR. Do not place the unit on a carpet because this will block the ventilation holes.
- Install the VCR in a horizontal position only.
- Avoid locations subject to strong vibrations.
- Avoid moving the VCR between cold and hot locations (see “Moisture Condensation Problems”, this page).
- Do not place the VCR directly on top of the TV, as this may cause playback or recording problems.

## Avoiding Electrical Shock and Fire

- Do not handle the power cord with wet hands.
- Do not pull on the power cord when disconnecting it from an AC wall outlet. Grasp it by the plug.
- If any liquid is spilled on the VCR, unplug the power cord immediately and have the unit inspected at a factory-authorized service center.
- Do not place anything directly on top of this VCR.

## Moisture Condensation Problems

### Cause:

When the VCR is first installed, moved from a cold area to a warm area or placed in a location with high humidity, dew (moisture) may form in the unit. The Dew indicator (d d d d) blinks. If you operate the VCR with dew inside, damage may result.

### Prevention:

- ❶ Do not operate the VCR for approximately 2 hours.

When the VCR reaches room temperature, the Dew indicator (d d d d) will turn off and the VCR will be ready for operation.

# CONTENTS

PRECAUTIONS .....	1
FEATURES .....	3
ACCESSORY .....	3
LOCATIONS OF CONTROLS AND INDICATORS ....	4
CONNECTIONS .....	8
ON-SCREEN MENU .....	9
SETTING THE LANGUAGE AND CLOCK .....	11
SUPERIMPOSE DISPLAY .....	13
VIDEO CASSETTE TAPES .....	14
TAPE MANAGEMENT .....	16
NORMAL RECORDING .....	19
AUTOREPEAT RECORDING .....	22
ALARM RECORDING .....	23
SERIES RECORDING .....	26
PLAYBACK .....	27
DAY/TIME SEARCH .....	28
SECURITY LOCK .....	28
CLOCK ADJUSTMENT .....	29
SETTING THE CASSETTE EJECT MODE .....	30
CHECKING POWER FAILURE, FAILURE DUE TO CONDENSATION AND USAGE DURATION ....	31
OUTPUT TERMINALS .....	32
MAINTENANCE .....	36
TROUBLESHOOTING GUIDE .....	38
SPECIFICATIONS .....	39
WARRANTY .....	40

# FEATURES

- Tape management function
- High-speed Fast Forward/Rewind
- Field recording/playback
- Audio recording
- Autorepeat recording
- Series recording function
- Alarm recording function
- On-screen mode setting
- Integrated time date generator
- Day/Time search function
- Alarm scan/search function
- Forward/Reverse field advance function
- 30-day memory backup
- Security lock
- Automatic head cleaning function
- Thread check function
- 8-hour mode recording

# ACCESSORY

- ① Power cord

# LOCATIONS OF CONTROLS AND INDICATORS

## Front Panel

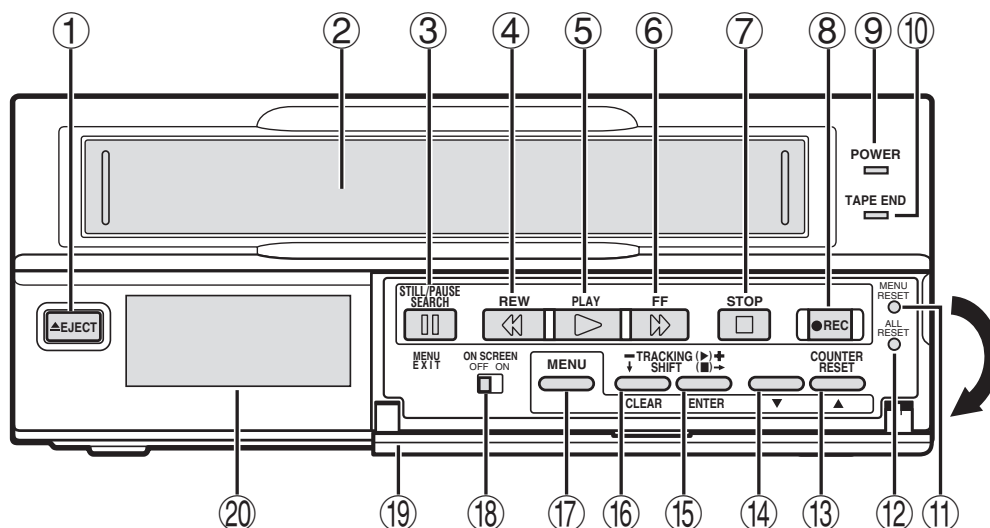

- ① **EJECT** button
- ② Cassette loading slot
- ③ **STILL/PAUSE** button  
**SEARCH** button  
**MENU EXIT** button
- ④ **REW** (rewind) button
- ⑤ **PLAY** button
- ⑥ **FF** (fast forward) button
- ⑦ **STOP** button
- ⑧ **REC** (record) button
- ⑨ **POWER** indicator
- ⑩ **TAPE END** indicator  
Flashes during output from the **TAPE END OUT** terminal.
- ⑪ **MENU RESET** button
- ⑫ **ALL RESET** button
- ⑬ **COUNTER RESET** button  
▲ button
- ⑭ ▼ button
- ⑮ **TRACKING +** button  
**SHIFT →** button  
**ENTER** button
- ⑯ **TRACKING -** button  
**SHIFT ↓** button  
**CLEAR** button
- ⑰ **MENU** button  
Press this button to display the menu.  
Buttons ⑬, ⑭, ⑮ and ⑯ are used for menu control.
- ⑱ **ON SCREEN** switch
- ⑲ Front door
- ⑳ Digital display panel

# LOCATIONS OF CONTROLS AND INDICATORS

## Digital Display

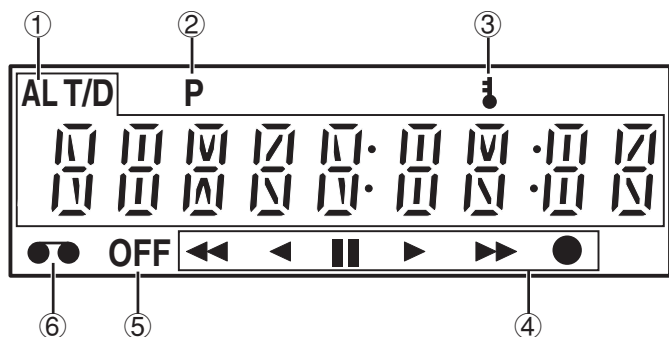

- Time display (No tape)

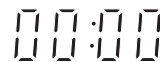

- Linear time counter display (Tape inserted)



- Dew display

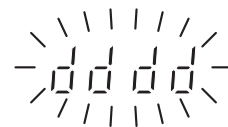

- Tracking control display



### ① Mode display

- Warning display



N flashes: Mode changed to non-recording mode while recording was in progress.

M flashes: Problem with mechanism.

V flashes: Video loss has occurred.

A flashes: Alarm recording in progress.

When alarm recording finishes, AL lights.

AL flashes during alarm recording.

### NOTES:

- The warning details appear according to the (WARNING OUT/EJECT SET) menu setting.
- The warning display has priority over other types of display. (Refer to "WARNING OUT Terminal" on page 34.)
- To cancel the display press the **STOP** button.

- Recording/playback speed mode



- Alarm search setting display

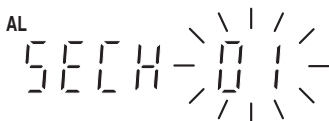

- Alarm scan setting display



- Day/Time search setting display

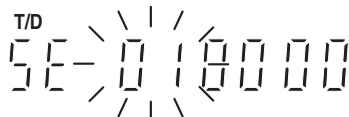

### ② Power failure indicator

Lights after a power failure.

#### NOTE:

- To cancel the "P" display, press the **MENU RESET** button.

### ③ Security lock indicator

Lights when the security lock is engaged.

## LOCATIONS OF CONTROLS AND INDICATORS

### ④ Operation Indicators

- They display the actual operation mode.

Operation Mode	Indicator
Record (REC)	●
Record pause (REC PAUSE)	● + -  -
Playback (PLAY)	▶
Still image (STILL)	▶ + -  -
Fast forward (FF)	▶▶
Rewind (REW)	◀◀
Forward picture search	▶ + ▶▶
Reverse picture search	▶ + ◀◀
Forward field advance	+ ▶
Reverse field advance	+ ◀

### ⑤ OFF indicator

Lights when the tape end has been reached after recording.

### ⑥ Cassette indicator

Lights when a cassette is loaded.

# LOCATIONS OF CONTROLS AND INDICATORS

## Back Panel

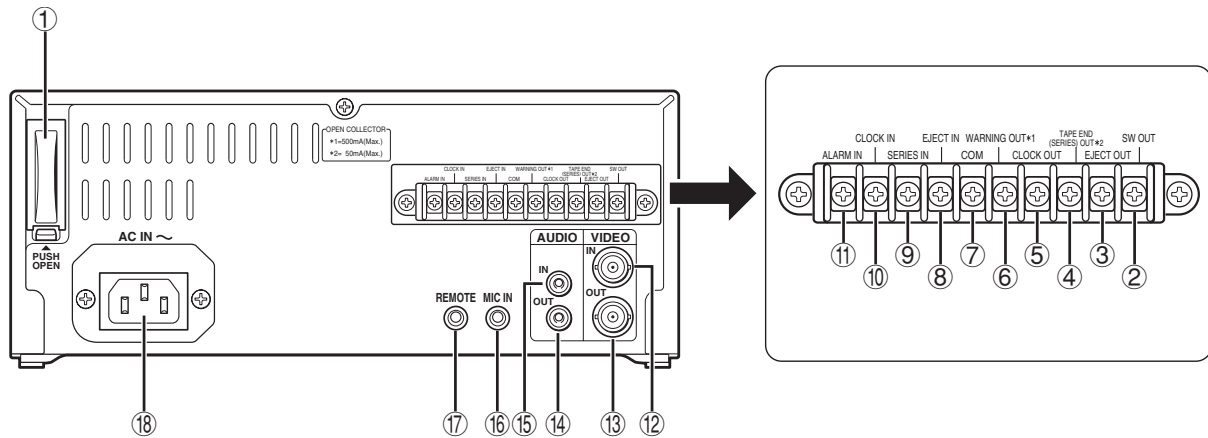

- ① Battery compartment
- ② SW OUT (switch output) terminal
- ③ EJECT OUT (eject trigger output) terminal
- ④ TAPE END OUT (tape end output) terminal  
SERIES OUT (series recording trigger output) terminal
- ⑤ CLOCK OUT (external clock set trigger output) terminal
- ⑥ WARNING OUT (warning output) terminal
  - Signals are output when an alarm, video loss, non-recording or mechanism problem occurs.
- ⑦ COM terminal
- ⑧ EJECT IN (eject trigger input) terminal
- ⑨ SERIES IN (series recording trigger input) terminal
- ⑩ CLOCK IN (external clock set trigger input) terminal
- ⑪ ALARM IN (alarm trigger input) terminal
- ⑫ VIDEO IN (video input) jack
- ⑬ VIDEO OUT (video output) jack
- ⑭ AUDIO OUT (audio output) jack
- ⑮ AUDIO IN (audio input) jack
- ⑯ MIC IN (microphone input) jack
- ⑰ REMOTE (remote control input) jack
- ⑱ AC power input

### NOTE:

- The terminal may be damaged by a torque of 0.49 N·m (5kg·cm) or more and by using screwdriver with a tip with a diameter of 6 mm or more.



# CONNECTIONS

Connect the video camera and TV monitor as shown in the figure below.

**NOTE:** Before making the connections, make sure the devices are disconnected from the power outlet.

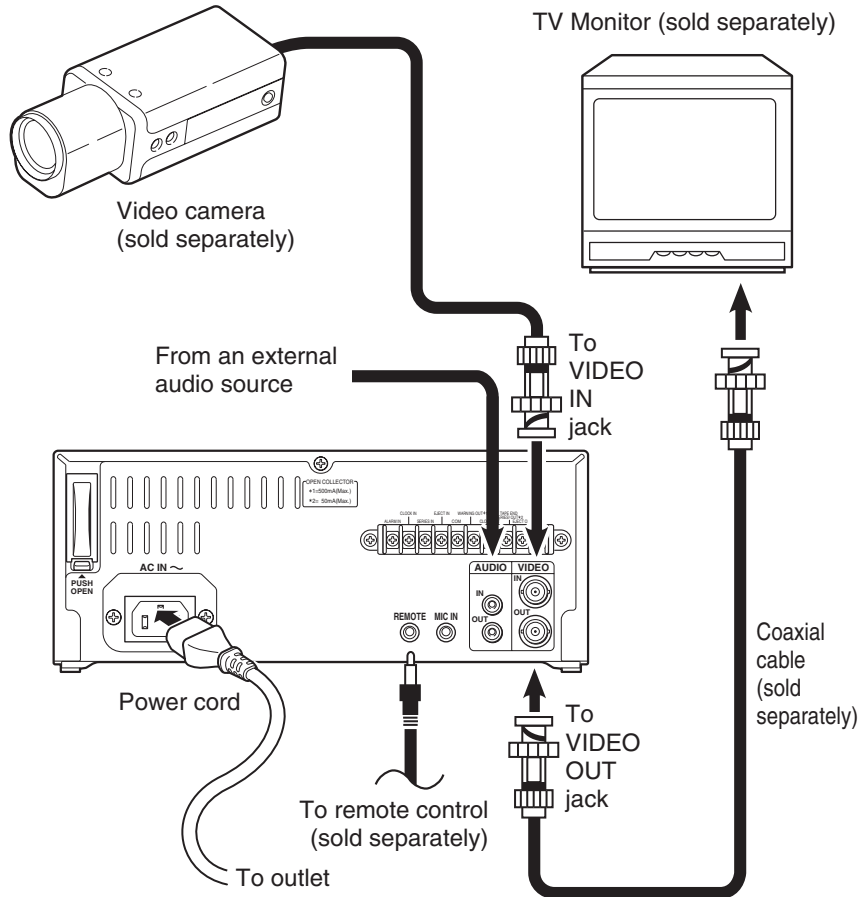

## Power Cord Installation

- 1 Plug the supplied power cord firmly into the AC power input **AC IN ~** socket.
- 2 Insert the plug of this power cord into a outlet.

## NOTES:

- The grounded power cord (3-pin plug) must be connected to a grounded power outlet.
- For more details, please refer to the manuals accompanying all other devices. If the connections are not made properly, it may cause a fire or damage the equipment.
- You can use a VA-RMN01 Remote Control Unit (sold separately) to control the VCR remotely.
- If there is no video signal when the power is turned on, "NO VIDEO" will be displayed on-screen.

# ON-SCREEN MENU

## Main Menu

To access on-screen menu

- 1 When no menu is displayed on-screen, press the **MENU** button.
  - o *The MAIN MENU appears.*

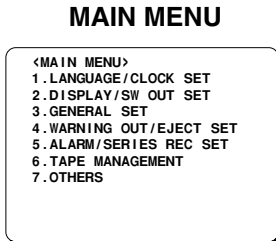

- 2 Press the **MENU EXIT** (or **MENU**) button to return to the monitor screen.

## Using the ▼, ▲, ENTER and CLEAR buttons for setting

### ▼ (or ▲) button

- When the display is highlighted in a MAIN MENU, select a sub-menu.
- When the display is highlighted in a sub-menu, select a setting item.
- While the display is flashing, the selected data setting will change or the selected setting value will increase or decrease.

### ENTER button

- After making the setting, press this button to save the setting and move to the next setting.
- When a MAIN MENU is being displayed, press this button and the sub-menu for selection will appear.
- When a menu is being displayed, press this button to change the selected setting item from highlighted to flashing.
- If there are several items on one line, press this button to confirm the setting and move to the next item (on the right).

### CLEAR button

- When a sub-menu is being displayed, press this button and the MAIN MENU will appear.
- If there are several items on one line, press this button to move to the previous item (on the left).

## Sub-menus

To enter or modify settings within a sub-menu

- 1 When a MAIN MENU is being displayed, press the ▼ (or ▲) button to select one of the sub-menus, then press the **ENTER** button.
  - o *The selected sub-menu appears.*
- 2 Press the ▼ (or ▲) button to move the selection to the desired setting, then press the **ENTER** button.
  - o *The selected item flashes.*
- 3 Press the ▼ (or ▲) button to enter or modify the setting.
- 4 Press the **MENU EXIT** button to save the settings and return to the monitor screen.

## LANGUAGE/CLOCK SET menu

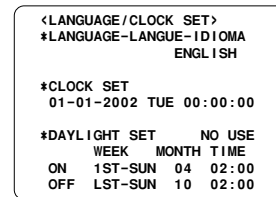

## DISPLAY/SW OUT SET menu

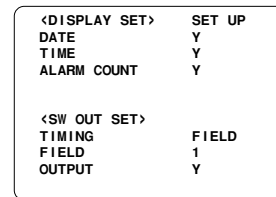

## GENERAL SET menu

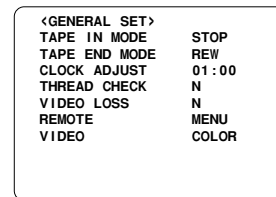

# ON-SCREEN MENU

## WARNING OUT/EJECT SET menu

<WARNING OUT SET>SET UP	
ALARM	Y
NON REC	N
MECHA. PROBLEM	Y
VIDEO LOSS	Y
<EJECT SET>	
EJECT MODE	EJECT1
OPERATION	SLAVE

### NOTE:

- The “VIDEO LOSS” line does not appear if “VIDEO LOSS” is set to “N” in the (GENERAL SET) menu.

## ALARM/SERIES REC SET menu

<ALARM/SERIES REC SET>	
*ALARM SET	
MODE	Y
DURATION	20S
*SERIES REC	N
*TAPE END OUT	8:00

## TAPE MANAGEMENT menu

<TAPE MANAGEMENT>	
*TAPE MANAGEMENT	N
*PROTECT DAY	30
*REC PASS SET	10
*GROUP NO. SET	OFF
*OVERRIDE	N

## OTHERS menu

<OTHERS>	
*ALARM LOG	
*POWER FAILURE/DEW	

## ALARM LOG menu

<ALARM LOG>		000
001	----	---
002	----	---
003	----	---
004	----	---
005	----	---
006	----	---
007	----	---
008	----	---
009	----	---
010	----	---

## POWER FAILURE/DEW/USED TIME menu

<POWER FAILURE>		
000 FAILURE	----	---
RECOVERY	----	---
<DEW>		
000 FAILURE	----	---
RECOVERY	----	---
<USED TIME>		
VIDEO	00000H	
POWER	00000H	

## NOTES:

- Setting items are highlighted (appear in blue characters) when they are selected.
- Settings flash while they are being changed.
- When a menu is displayed, recording will not be possible.
- During recording or playback the menus cannot be displayed.
- To reset the settings of a menu to their original values, select the desired menu and then press the **MENU RESET** button.
- The USED TIME data in the (POWER FAILURE/DEW/USED TIME) menu cannot be cleared even when the **MENU RESET** button is pressed.
- Press the **MENU** button to save any settings made and switch menu screens. To display the (ALARM LOG) menu or (POWER FAILURE/DEW/USED TIME) menu, select the “ALARM LOG” or “POWER FAILURE/DEW” line in the (OTHERS) menu and then press the **ENTER** button.
- Press the **CLEAR** button while a setting item is highlighted (appears in blue characters) to return to the main menu. In the case of the (ALARM LOG) menu or the (POWER FAILURE/DEW/USED TIME) menu, to return to the (OTHERS) menu.

# SETTING THE LANGUAGE AND CLOCK

## Language Setting

English, French, Spanish or Portuguese can be selected by the user.

- 1 Turn the power on to all devices used.
- 2 Press the **MENU** button to display the MAIN MENU.
  - o The "1.LANGUAGE/CLOCK SET" line appears highlighted.

```
<MAIN MENU>
1. LANGUAGE/CLOCK SET
2. DISPLAY/SW OUT SET
3. GENERAL SET
4. WARNING OUT/EJECT SET
5. ALARM/SERIES REC SET
6. TAPE MANAGEMENT
7. OTHERS
```

- 3 Press the **ENTER** button.
  - o The (LANGUAGE/CLOCK SET) menu appears.
  - o "ENGLISH" is highlighted (appears in blue characters).

```
<LANGUAGE/CLOCK SET>
*LANGUAGE-LANGUE-IDIOMA
ENGLISH

*CLOCK SET
01-01-2002 TUE 00:00:00

*DAYLIGHT SET      NO USE
WEEK  MONTH TIME
ON  1ST-SUN  04  02:00
OFF LST-SUN  10  02:00
```

- 4 Press the **ENTER** button.
  - o The display color for the selected item returns to the original color and flashes.
- 5 Press the ▼ (or ▲) button to select the language of your choice.
  - To set the next item, press the **ENTER** button, then press the ▼ (or ▲) button to select the next setting.
- 6 When finished, press the **MENU EXIT** button to return to the monitor screen.

## Clock setting

**Example:** To set the clock to October 15, 2002 at 3:20 PM (15:20).

- 1 Follow steps 1 to 3 under "Language Setting".
- 2 Press the ▼ (or ▲) button until the "CLOCK SET" setting is highlighted (appears in blue characters).
- 3 Press the **ENTER** button.
  - o The month position starts flashing.
- 4 Press the ▼ (or ▲) button to set the month (10), then press the **ENTER** button.
  - o The day of week is set automatically.
- 5 Press the ▼ (or ▲) button to set the day (15), then press the **ENTER** button.
- 6 Press the ▼ (or ▲) button to set the year (2002), then press the **ENTER** button.
- 7 Press the ▼ (or ▲) button to set the hours (15 for 3 PM), then press the **ENTER** button.
  - o Unit uses 24hours format.
- 8 Press the ▼ (or ▲) button to set the minutes (20), then press the **ENTER** button.

```
<LANGUAGE/CLOCK SET>
*LANGUAGE-LANGUE-IDIOMA
ENGLISH

*CLOCK SET
10-15-2002 TUE 15:20:00

*DAYLIGHT SET      NO USE
WEEK  MONTH TIME
ON  1ST-SUN  04  02:00
OFF LST-SUN  10  02:00
```

- If a wrong setting has been entered, press the **CLEAR** button to move to the setting to be changed, then press the ▼ (or ▲) button to enter the correct setting.
- 9 For accurate clock setting, press the ▼ button timed with a time broadcast or other accurate time signal. This will start the seconds counting from 00.
    - To set the next item, press the **ENTER** button, then press the ▼ (or ▲) button to select the next setting.
  - 10 Press the **MENU EXIT** button to return to the monitor screen.

## NOTE:

- In STOP mode, press and hold the **STOP** button then press the **TRACKING** – button to reset the minutes and seconds to 00 (to the closest hour). For example, between 13:30:00 and 14:29:59 the clock is reset to 14:00:00.

# SETTING THE LANGUAGE AND CLOCK

## Automatic Daylight Saving Time Adjustment

- 1 Follow steps 1 to 3 under “Language Setting” on page 11.

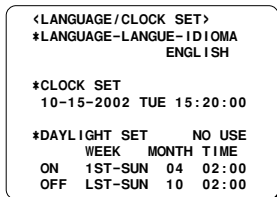

- 2 Press the ▼ (or ▲) button until the “DAYLIGHT SET” setting is highlighted (appears in blue characters), then press the **ENTER** button.
- 3 Press the ▼ (or ▲) button to set the auto daylight saving time/standard time adjustment, then press the **ENTER** button.

NO USE . . . . . No daylight saving time/standard time adjustment is made.

USE . . . . . The auto daylight saving time/standard time adjustment is made.

o If using the “USE” setting, continue with steps 4 to 7.

- 4 Press the ▼ (or ▲) button to select the “ON” line setting, then press the **ENTER** button.

o The “1ST” of the “ON” line flashes.

- 5 Set the day the daylight saving time adjustment is made.

- Press the ▼ (or ▲) button to set the week, then press the **ENTER** button.  
1ST, 2ND, 3RD, 4TH or LST (first, second, third, fourth or last)
- Press the ▼ (or ▲) button to set the day of week, then press the **ENTER** button.  
SUN, MON, TUE, ..... SAT (Sunday, Monday, Tuesday....Saturday)
- Press the ▼ (or ▲) button to set the month the daylight saving time adjustment is made, then press the **ENTER** button.  
01, 02,.....11, 12 (for January, February.....November, December)
- Press the ▼ (or ▲) button to set the time (hour) the daylight saving time adjustment is made, then press the **ENTER** button.
- Press the ▼ (or ▲) button to set the time (minutes) the daylight saving time adjustment is made, then press the **ENTER** button.

- 6 Press the ▼ (or ▲) button to select the “OFF” line setting, then press the **ENTER** button.

o The “LST” of the “OFF” line flashes.

- 7 Following the same procedure as above (step 6), set when the time is changed back from daylight saving time to standard time.

- 8 Press the **MENU EXIT** button.

### Factory setting:

	WEEK	MONTH	TIME
ON	1ST-SUN	04	02:00 (AM)
OFF	LST-SUN	10	02:00 (AM)

# SUPERIMPOSE DISPLAY

## Selecting the Superimpose Display

You can select to display or not the date, time and number of alarm recordings.

- 1 Turn the power on to all devices used.
- 2 Press the **MENU** button to display the MAIN MENU.
- 3 Press the **▼** (or **▲**) button to select the "2.DISPLAY/SW OUT SET" line, then press the **ENTER** button.

o *The (DISPLAY/SW OUT SET) menu appears.*

<DISPLAY SET>	SET UP
DATE	Y
TIME	Y
ALARM COUNT	Y
<SW OUT SET>	FIELD
TIMING	1
OUTPUT	Y

- 4 Press the **ENTER** button.
- 5 Press the **▼** (or **▲**) button to select the desired mode, then press the **ENTER** button.  
SET UP . . . . . Set each item (Individual)  
ALL Y . . . . . To set all items to "Y"  
ALL N . . . . . To set all items to "N"  
o *If using the "SET UP" setting, continue with steps 6 to 8.*
- 6 Press the **▼** (or **▲**) button until the item to be changed is highlighted, then press the **ENTER** button.
- 7 Press the **▼** (or **▲**) button to set "Y" (displayed) or "N" (not displayed), then press the **ENTER** button.  
DATE . . . . . The date appears  
TIME . . . . . The time appears  
ALARM COUNT . . . . . The number of alarm recordings appears
- 8 Repeat steps 6 and 7 when setting other items.
- 9 When finished, press the **MENU EXIT** button.

### NOTE:

- If the **ON SCREEN** switch is set to the "ON" position, the items for which "Y" have been set are recorded. The items for which "N" was set at step 7 above are not recorded.

## Changing the Superimpose Display Position

- 1 Turn the power on to all input devices to the VCR.
- 2 Set the **ON SCREEN** switch to the "ON" position.

o *The superimpose display appears.*

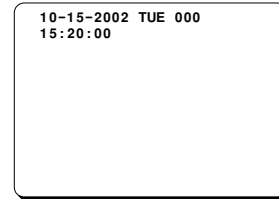

- 3 To change the display position, press the **SHIFT →** (or **↓**) button.

o *The display will move towards the right (or the bottom).*

### NOTES:

- If the **SHIFT →** (or **↓**) button is kept pressed for 1 second or more, the display will move at a faster speed.
- The display position cannot be changed during recording.

# VIDEO CASSETTE TAPES

Use only video cassette tapes bearing the VHS logo. This VCR was primarily designed for use with T-160 cassette tapes. It is recommended that you use T-160 standard grade VHS video cassette tapes for optimal performance.

## NOTE:

- If using longer tapes (i.e. T-180) the tape travel will not be as stable and that may cause problems.

## Handling Cassette Tapes

The cassette tapes should always be stored vertically in their cases, away from high temperatures, magnetic fields, direct sunlight, dirt, dust and locations subject to mold formation.

Do not tamper with the cassette mechanism and never touch the tape with your fingers.

Protect the cassette tapes from shocks and strong vibrations.

## To Protect your Recordings

After having recorded a tape, if you wish to keep the recording, use a flat-tripped screwdriver to break off the erasure-prevention tab on the cassette.

To record again on a tape without an erasure-prevention tab, cover the hole with adhesive tape.

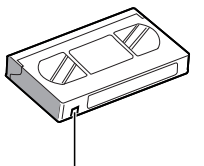

Erasure-prevention tab

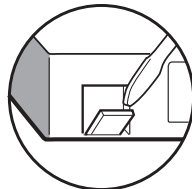

## Precautions concerning the video cassette tapes

- Do not use tapes that are damaged, tapes that have been cut and repaired or tapes that have been altered in any way.
- Some rewinders may tangle the tape, and therefore their use is not recommended.
- When tapes are recorded over and over again, the recording quality will deteriorate. Refer to "Concerning the Number of Times Tapes can be Rerecorded on" on page 19, and replace the tape with a new tape as required.

## Loading

- ① Place the cassette, label side up, in the loading slot. Gently push the center of the cassette until it is loaded automatically.

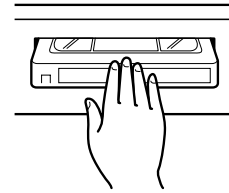

- The time display will switch to the reset counter "0:00:00" display.
- The cassette indicator "●●" lights on the digital display.

## NOTE:

- If you try to record on a cassette without an erasure-prevention tab, the VCR will eject the cassette.

## Unloading

- ① In stop mode, press the **EJECT** button.
  - The cassette is automatically ejected.

## NOTES:

- Do not insert any other object in the cassette loading slot, as that may cause injury and damage to the VCR.
- If your hand gets stuck in the cassette loading slot, unplug the power cord and consult the dealer where the unit was bought. Do not forcibly pull your hand out as that may cause severe injuries.

# VIDEO CASSETTE TAPES

## Correct tape thread check function

This function checks to make sure that the cassette has been correctly loaded so that recording can be carried out.

### NOTES:

- After the cassette tape is loaded, the mechanism will operate for about 5 seconds to check that the tape has been threaded (loaded) correctly automatically and the cassette indicator “●” will flash during that period. If the tape is not loaded properly, the cassette will be ejected.
- If the **REC**, **PLAY**, **FF**, **REW** or **STOP** button is pressed during the tape thread check operation, the command will only be executed after the tape thread has been checked. Only the **EJECT** button will operate while the tape thread is being checked.
- If “TAPE IN MODE” in the (GENERAL SET) menu is set to “REC”, the recording indicator “●” will light while the tape thread is being checked. However, recording will only start after the tape thread check is completed.

- 1 Press the **MENU** button to display the MAIN MENU.
- 2 Press the ▼ (or ▲) button to select the “3.GENERAL SET” line, then press the **ENTER** button.
  - o *The (GENERAL SET) menu appears.*

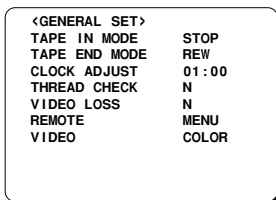

- 3 Press the ▼ (or ▲) button until the “THREAD CHECK” setting is highlighted, then press the **ENTER** button.
- 4 Press the ▼ (or ▲) button to select the desired mode, then press the **ENTER** button.
  - N . . . . . The correct tape thread check function is off
  - Y . . . . . The correct tape thread check function is on
- 5 Press the **MENU EXIT** button.

## Setting the Action to Take When a Cassette is Loaded

You can set the mode the VCR will go into when a cassette is loaded.

- 1 Press the **MENU** button to display the MAIN MENU.
- 2 Press the ▼ (or ▲) button to select the “3.GENERAL SET” line, then press the **ENTER** button.
  - o *The (GENERAL SET) menu appears.*
- 3 Press the ▼ (or ▲) button until the “TAPE IN MODE” setting is highlighted, then press the **ENTER** button.
- 4 Press the ▼ (or ▲) button to select the desired mode, then press the **ENTER** button.
  - STOP . . . . . When tape inserted the VCR, stays in stop mode
  - REC . . . . . When tape inserted the VCR, goes into recording mode
- 5 Press the **MENU EXIT** button.



# TAPE MANAGEMENT

This VCR is equipped with a tape management function. Using this function you can protect previous recordings and prevent overuse of the tape by controlling the tape protection term (number of days), the maximum number of re-recordings of the tape and the recording group. For details on how to set this function, refer to "Setting the Tape Management Function".

**PROTECT DAY:** To set the number of days before the tape can be rerecorded over.

**REC PASS SET:** To limit the number of rerecordings, in order to maintain a good image quality.

**GROUP NO. SET:** To manage tapes belonging to different recording groups.

## NOTES:

- Before using this function, make sure that the clock is set properly.
- To use the tape management function, it must be set before recording is started.
- The tape management data is recorded at the beginning of the tape.

## Operation

When the **REC** button is pressed, the VCR will rewind the tape to the beginning, and will play back some of the tape to check for the presence of tape management data (no image appears). The message "T. MANAGE. CHK" appears on-screen while the presence and type of data are being checked.

## NOTE:

- When performing alarm recording, the tape management function will not operate even if it is active.

## If no tape management data is present on the tape

Recording will start according to the settings in the (TAPE MANAGEMENT) menu.

When recording starts, the updated tape management data is recorded onto the tape.

If the tape has already been recorded on, the message "USED TAPE" will flash on-screen until recording starts.

## If tape management data is present on the tape

The tape management data is checked and if there is no conflict, the VCR will rewind the tape to the beginning, then recording starts and the updated tape management data is recorded onto the tape. The message "T. MANAGE. OK" appears on-screen while the tape is being rewound and the tape management data is being recorded.

If a conflict is found when the tape management data is checked, the (TAPE MANAGEMENT) menu is displayed and the conflicting setting will flash. This menu will show the settings taken from the data recorded on the tape and not the current data settings held in the VCR's (TAPE MANAGEMENT) menu setting. Refer to "Tape Management Conflict Display" for detailed information.

## NOTE:

- If the VCR is set for alarm recordings, alarms will be recorded based on the different settings. If an alarm signal is input while "T. MANAGE. CHK" is displayed, the alarms will be recorded after feeding a certain amount of tape but the data will not be recorded (updated). If an alarm signal is input during data recording, the alarms will be recorded after data recording.

## IMPORTANT NOTES:

- If the tape management data cannot be read, the VCR will switch to stop mode and "DATA NG" will be displayed on-screen. This may indicate that the beginning of the tape (data recording/reading section) is damaged and the tape may be unusable. The message "DATA NG" will disappear when the **EJECT** or **PLAY** button is pressed.
- **Set the security lock function to on in order to protect the security of this feature.**

# TAPE MANAGEMENT

## Setting the Tape Management Function

- 1 Press the **MENU** button to display the MAIN MENU.
- 2 Press the ▼ (or ▲) button to select the "6.TAPE MANAGEMENT" line, then press the **ENTER** button.
  - o The (TAPE MANAGEMENT) menu appears.

<TAPE MANAGEMENT>	
*TAPE MANAGEMENT	N
*PROTECT DAY	30
*REC PASS SET	10
*GROUP NO.SET	OFF
*OVERRIDE	N

- 3 Press the **ENTER** button.
  - 4 Press the ▼ (or ▲) button to select the desired mode, then press the **ENTER** button.
    - N. . . . . The tape management function is not active.
    - Y. . . . . The tape management function is active.
- When setting to "Y", please continue with the settings below.
- 5 Press the ▼ (or ▲) button until the "PROTECT DAY" setting is highlighted, then press the **ENTER** button.
  - 6 Press the ▼ (or ▲) button to select the desired number of days to protect the tape, then press the **ENTER** button.
    - OFF . . . . The tape is not protected.
    - 1-255 . . . Number of days to protect the tape (prevent over-recording), from the date of the last recording on the tape (or the last expected recording date (calculated using the tape length (T-160) and the recording speed)).

### NOTE:

- Since the last expected recording date is a calculated date (using the tape length (T-160) and the recording speed), it may be different from the actual last recording date, due to other settings such as alarm recordings.

- 7 Press the ▼ (or ▲) button until the "REC. PASS SET" setting is highlighted, then press the **ENTER** button.
  - OFF . . . . The number of re-recording times will not be checked.
  - 1-100 . . . Maximum number of re-recording times. (Refer to "Concerning the Number of Times Tapes can be Rerecorded on" on page 19.)

### NOTES:

- Since data is read before it is recorded, the number of times will be incremented even if the recording is stopped before the end.
- During autorepeat recording, the re-recording times count will be updated every time the tape is rewound to the beginning. Autorepeat recording will proceed even if the count exceeds the "REC PASS SET" setting.

- 9 Press the ▼ (or ▲) button until the "GROUP NO. SET" setting is highlighted, then press the **ENTER** button.
  - OFF . . . . The group number will not be checked.
  - 1-15 . . . . Group number setting.
- 11 Press the ▼ (or ▲) button until the "OVERRIDE" setting is highlighted, then press the **ENTER** button.
- 12 Press the ▼ (or ▲) button to select the desired override mode, then press the **ENTER** button. (Refer to "Tape Management Conflict Display" on the next page.)
  - N. . . . . Only **EJECT** button operation is accepted after a conflict has occurred.
  - Y. . . . . The next operation is accepted after a conflict has occurred. This will override setting.
- 13 Press the **MENU EXIT** button.

### NOTES:

- **Once the tape management data is recorded on tape, it cannot be changed.**
- The criteria (condition) for allowing recording will be based on the data recorded on the tape and not the settings in the (TAPE MANAGEMENT) menu.

# TAPE MANAGEMENT

## Tape Management Conflict Display

If a conflict that prevents recording is found when the tape management function checks the tape data, the (TAPE MANAGEMENT) menu appears with the conflicting setting flashing and the VCR go into the stop mode.

### NOTES:

- If "OVERRIDE" is set to "N" (No), the conflicting setting is displayed flashing and the message (PRESS EJECT) appears at the bottom of the screen. Recording under these conditions is not possible. Press the **EJECT** button to eject the tape. To record on the same tape, set the "OVERRIDE" setting to "Y" and modify the conflicting setting, then insert the same tape and press the **REC** button. However, if only "PROTECT DAY" and "REC PAS SET" are modified, the menu will be displayed again. Press the **REC** button one more time to start recording. Recording starts and the tape data is updated.

### Conflict display sample

<TAPE MANAGEMENT>	
*TAPE MANAGEMENT	Y
*PROTECT DAY	30
LAST M/D	NEXT M/D
10/15	11/15
*REC PASS SET	10
PASS COUNT	10
*GROUP NO.SET	7
REC GR.NO.	8
*OVERRIDE	N
(PRESS EJECT)	

- If the "OVERRIDE" is set to "Y" (Yes), the (TAPE MANAGEMENT) menu is displayed and conflicting setting preventing recording will flash and the VCR will switch to stop mode.  
To enter recording mode, press the **REC** button.

## PROTECT DAY CONFLICT

The tape is protected, and the tape protection term (ex. 30 days) is not yet over.

Under "LAST M/D", the date of the last recording on the tape (or the last expected recording date (calculated using the tape length (T-160) and the recording speed)) is displayed.

Under "NEXT M/D", the date when it will be possible to record on the tape again is displayed.

## REC PASS SET CONFLICT

The set number of recording passes has been reached.

The "PASS COUNT" shows the number of recording passes on the tape (ex. since the maximum recording passes number is set to "10", this prevents further recording.)

### NOTES:

- When conducting Autorepeat recording, if the "PASS COUNT" exceeds 100, "101\*" will be displayed flashing.
- If using a tape recorded previously on a different type of VCR (no tape data), when the set number of recordings is exceeded, "USED" will flash next to the "PASS COUNT" number.

## GROUP NO. SET CONFLICT

The group numbers do not match.

The "REC GR. NO." shows the tape recording group number (ex. this tape belongs to a different recording group number 8 than the one set 7.)

# NORMAL RECORDING

## Normal Recording

### Before starting

- Turn the power on to all devices used.
- Load a cassette tape with its erasure-prevention tab intact.
- Set the **ON SCREEN** switch to the "ON" position.

#### NOTE:

- If "TAPE IN MODE" is set to "REC" in the (GENERAL SET) menu, recording will start.

- 1 Press the **REC** button.
  - The record indicator "●" lights.
  - Recording starts.
  - If the tape end is reached while recording, "OFF" is displayed on the digital display and the unit goes into the mode set at the "TAPE END MODE" setting in the (GENERAL SET) menu. To cancel the "OFF" display, press the **STOP**, **EJECT**, **FF**, **REW** or **PLAY** button.
  - When the end of the tape is reached, the **TAPE END OUT** terminal output will be 0V. To cancel the output, press the **STOP** button.
- 2 To stop recording, press the **STOP** button.

#### NOTES:

- A tape recording made on this VCR may not play back with the same degree of clarity on a real time video cassette recorder from another manufacturer.
- If you press the **REC** button and the loaded cassette has no erasure-prevention tab, the VCR will eject the cassette.

### [Recording Speed Mode]

Recording speed mode (hour mode)	Maximum recording duration (hours)	Recording interval (second)	Audio recording	Tape motion
8	8	1/60	Possible	Continuous

## Record Pause

Recording can be interrupted temporarily.

- 1 Press the **STILL/PAUSE** button during recording.
  - The pause/still indicator "II" flashes.

#### NOTES:

- The image appears on-screen but it is not recorded.
  - If a recording pause continues for 5 minutes or more, the VCR will switch to stop mode to avoid damaging the tape.
- 2 To resume recording, press the **REC** button, or press the **STILL/PAUSE** button again.

## Concerning the Number of Times Tapes can be Rerecorded on

Depending on the recording speed mode, the tape must be replaced after a certain number of recording times.

Refer to the table below for the maximum number of times a tape can be recorded on.

Recording speed mode (hour mode)	Maximum number of recording times (with a standard grade tape)
8	100

#### NOTES:

- The maximum number of recording times will vary depending on the location and kind of tape used. Verify the recording quality and replace the tape when the quality starts to deteriorate. The maximum number of recording times indicated above are based on test tapes (T-160) used by the company.
- It is recommended that tape be changed at least as often as in the above table to provide good picture quality in the mode above.

## NORMAL RECORDING

### Tape Counter Notes:

- There is no tape counter indication for the blank portions of the tape.
- The tape counter indicates real hours, minutes and seconds.
- There may be a slight discrepancy between the position shown on the tape counter and the actual tape position.
- When rewinding the tape past the "0:00:00" position, a minus (-) sign will be displayed.
- When the counter is displayed on the digital display panel, press the **COUNTER RESET** button to reset it to 0:00:00.

### Action to Take when the Video Signal Deteriorates

If there is no video signal during recording or when a menu is not displayed (in stop, fast forward or rewind modes, etc.), "VIDEO LOSS" can be displayed on-screen. If in the (WARNING OUT/EJECT SET) menu, "VIDEO LOSS" is set to "Y", the output at the **WARNING OUT** terminal becomes 0V (Low) (Refer to "WARNING OUT Terminal" on page 34).

- ① Press the **MENU** button to display the MAIN MENU.
- ② Press the ▼ (or ▲) button to select the "3.GENERAL SET" line, then press the **ENTER** button.
  - The (GENERAL SET) menu appears.

<GENERAL SET>	
TAPE IN MODE	STOP
TAPE END MODE	REW
CLOCK ADJUST	01:00
THREAD CHECK	N
VIDEO LOSS	N
REMOTE	MENU
VIDEO	COLOR

- ③ Press the ▼ (or ▲) button until the "VIDEO LOSS" setting is highlighted, then press the **ENTER** button.
- ④ Press the ▼ (or ▲) button to select the desired mode, then press the **ENTER** button.
  - N. . . . . The video loss warning is not active.
  - Y. . . . . The video loss warning is active.
- ⑤ Press the **MENU EXIT** button.

## NORMAL RECORDING

### Setting the Mode at the End of the Tape

You can select the mode on the VCR when the tape reaches the end during recording.

- 1 Press the **MENU** button to display the MAIN MENU.
- 2 Press the ▼ (or ▲) button to select the "3.GENERAL SET" line, then press the **ENTER** button.
  - o The (GENERAL SET) menu appears.

<GENERAL SET>	
TAPE IN MODE	STOP
TAPE END MODE	REW
CLOCK ADJUST	01:00
THREAD CHECK	N
VIDEO LOSS	N
REMOTE	MENU
VIDEO	COLOR

- 3 Press the ▼ (or ▲) button until the "TAPE END MODE" setting is highlighted, then press the **ENTER** button.
- 4 Press the ▼ (or ▲) button to select the desired mode, then press the **ENTER** button.
  - **Setting when not using Autorepeat recording**
    - REW. . . . . Rewinds the tape to the beginning, then goes to stop mode
    - STOP . . . . . Goes to stop mode
    - EJECT . . . . . The cassette is ejected
  - **Setting when using Autorepeat recording**
    - REPEAT1. . . Autorepeat recording mode is automatically canceled if there was an alarm trigger
    - REPEAT2. . . Autorepeat recording mode is active even if there was an alarm trigger
- 5 Press the **MENU EXIT** button.

### Setting the video input signal

The video input signal during recording can be set to either color or black & white.

- 1 Press the **MENU** button to display the MAIN MENU.
- 2 Press the ▼ (or ▲) button to select the "3.GENERAL SET" line, then press the **ENTER** button.
  - o The (GENERAL SET) menu appears.
- 3 Press the ▼ (or ▲) button until the "VIDEO" setting is highlighted, then press the **ENTER** button.
- 4 Press the ▼ (or ▲) button to select the desired mode, then press the **ENTER** button.
  - COLOR . . . . For recording in color
  - B/W . . . . . For recording in black & white
- 5 Press the **MENU EXIT** button.

#### NOTES:

- Set to "COLOR" for systems which include color signals (including cases where black & white signals are mixed in), and set to "B/W" for systems which only use black & white signals.
- Use the same setting for recording and playback.
- If tapes that have been recorded in black & white are played back when the setting is at "COLOR", the recordings will not be played back in color.
- If using a black & white camera, set to "B/W". Recordings will not be made in color even if "COLOR" is set.

# AUTOREPEAT RECORDING

## Autorepeat Recording

The same tape can be recorded over many times.

- Follow the **Before starting** steps, under “NORMAL RECORDING”.
- ❶ Press the **MENU** button to display the MAIN MENU.
- ❷ Press the ▼ (or ▲) button to select the “3.GENERAL SET” line, then press the **ENTER** button.
  - *The (GENERAL SET) menu appears.*

<GENERAL SET>	
TAPE IN MODE	STOP
TAPE END MODE	REW
CLOCK ADJUST	01:00
THREAD CHECK	N
VIDEO LOSS	N
REMOTE	MENU
VIDEO	COLOR

- ❸ Press the ▼ (or ▲) button until the “TAPE END MODE” setting is highlighted, then press the **ENTER** button.
- ❹ Press the ▼ (or ▲) button to set to “REPEAT1” or “REPEAT2” (Refer to “Setting the Mode at the End of the Tape.” on page 21), then press the **ENTER** button.
- ❺ Press the **MENU EXIT** button.
- ❻ Press the **REC** button.
  - *Recording starts. When the tape end is reached, the VCR will rewind it to the beginning, and recording will resume.*
  - *When the end of the tape is reached, “OFF” will be displayed and **TAPE END OUT** terminal output will 0 V, until the rewinding operation starts.*
- ❼ To stop recording, press the **STOP** button.

## NOTES:

- If there is an alarm trigger during autorepeat recording, “AL” and “A” flash on the digital display and alarm recording starts. (Refer to “ALARM RECORDING” on page 23.)
- If the “TAPE END MODE” setting is “REPEAT1” and there is an alarm trigger, the recording will continue to the end of the tape, and then the tape will be rewound to the beginning and stop. “OFF” will be displayed on the digital display.  
To turn off the “OFF” display, press the **STOP**, **EJECT**, **FF**, **REW** or **PLAY** button.
- If “AL” appears on the digital display and the “TAPE END MODE” setting is “REPEAT1”, autorepeat recording is not possible.

# ALARM RECORDING

By connecting the **ALARM IN** terminal to a normally open door switch, an interphone, etc., a recording can be done only when necessary.

## Alarm Recording Setting

Alarm recording is performed when there is an input (trigger) at the **ALARM IN** terminal.

- Make all necessary connections.
- The alarm triggers are received while in recording and stop modes.
- Follow the **Before starting** steps, under “NORMAL RECORDING”.

① Press the **MENU** button to display the MAIN MENU.

② Press the ▼ (or ▲) button to select the “5.ALARM/SERIES REC SET” line, then press the **ENTER** button.

○ The (ALARM/SERIES REC SET) menu appears.

<ALARM/SERIES REC SET>	
*ALARM SET	
MODE	Y
DURATION	20S
*SERIES REC	N
*TAPE END OUT	8:00

③ Press the ▼ (or ▲) button until the “MODE” setting is highlighted, then press the **ENTER** button.

④ Press the ▼ (or ▲) button to set the desired alarm recording mode, then press the **ENTER** button.

Y. . . . . Alarm recording is done when there is an alarm trigger.

N. . . . . Alarm recording is not performed even if there is an alarm trigger.

⑤ Press the **ENTER** button.

⑥ Press the ▼ (or ▲) button to set the desired alarm recording duration (20S, 40S, 1M, 2M, 3M, 4M, 5M, or CC), then press the **ENTER** button.

20S-5M. . . Recording only for the displayed duration

CC . . . . . Recording as long as the alarm signal is being input (minimum 5 seconds)

⑦ Press the **MENU EXIT** button.

## NOTES:

- During alarm recording all buttons are disabled.
- If “OFF” appears on the digital display, alarm recording is not possible in order to prevent the recorded tape to be recorded over. To cancel the “OFF” display, press the **STOP**, **EJECT**, **FF**, **REW** or **PLAY** button.
- If an alarm trigger is received while alarm recording is in progress, recording duration for the second alarm will be calculated from that point. The alarm counter will register the alarm, but it will not be found during an alarm scan and alarm search.
- If there is a power failure during alarm recording, and the power is restored within the recording set duration, alarm recording will continue.
- If the alarm recording duration is short, the alarms may not be found during an alarm scan or an alarm search. If the alarms are going to be reviewed using alarm scan or alarm search, then a 20-second or more recording duration should be used.
- To do alarm recording during series recording, set “MODE” to “Y”. Alarm recording will be conducted only if the VCR is recording.



# ALARM RECORDING

## Alarm Recording Counter Display

- During alarm recording, “AL” and “A” will be flashing on the digital display.
- If a superimpose display is being displayed and “ALARM COUNT” has been set to “Y” in the (DISPLAY/SW OUT SET) menu, the number of alarm recordings will flash on the monitor screen.
- The maximum display number of alarm recordings is “999”. At the next alarm recording the counter will indicate “000”.
- When the (ALARM LOG) menu appears, press the **MENU RESET** button to reset the alarm counter to “000” (all the data of the (ALARM LOG) menu is reset).

## Connections to the ALARM IN Terminal

- Alarm input signal  
Connect a make-contact (no voltage) switch between the **ALARM IN** and **COM** terminals.

## Checking the Alarm Recordings Time

- ① Press the **MENU** button to display the MAIN MENU.
- ② Press the ▼ (or ▲) button to select the “7.OTHERS” line, then press the **ENTER** button.

○ The (OTHERS) menu appears.

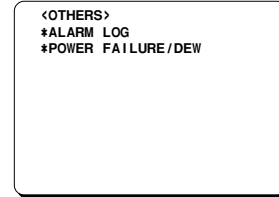

- ③ Press the ▼ (or ▲) button to select the “ALARM LOG” line, then press the **ENTER** button.

○ The (ALARM LOG) menu appears.

○ The number of alarm recordings, and the 10 most recent alarm recording times are displayed.

### Example

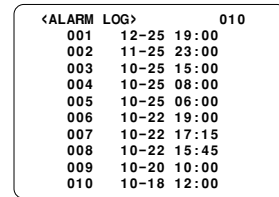

- Continue pressing the ▼ (or ▲) button to display the next (or previous) 10 alarm recording entries. When the number of alarm recording entries reaches 100, the older ones are erased as new ones are memorized.

- ④ Press the **MENU EXIT** button.

### NOTE:

- If the **MENU RESET** button is pressed while the (ALARM LOG) menu is displayed, the displayed data is erased. “AL” will be erased from the digital display.

# ALARM RECORDING

## Alarm Search

To go to the beginning of a desired alarm recording.

- 1 Press the **SEARCH** button during stop mode.
  - o "AL SEARCH 01" appears on screen.
- 2 Press the ▼ (or ▲) button to set the desired alarm number (01 to 99), then press the **FF** (or **REW**) button.
  - o The desired alarm is searched for and a still image of the beginning of the alarm recording appears on-screen.

### NOTE:

- The alarm number is relative to the actual tape position. (Please refer to the illustration below.)

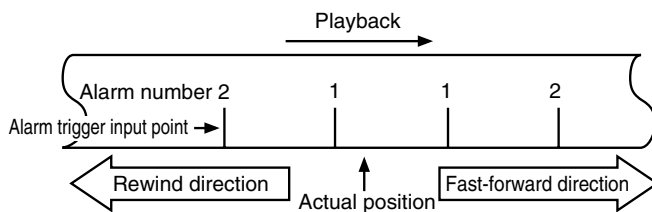

- 3 Press the **PLAY** button.
  - o Playback starts.

### NOTES:

- If the end of the tape is reached during a search, the tape will rewind and stop. If the beginning of the tape is reached, it will stop.
- This function does not operate when a warning display appears on the digital display.

## Alarm Scan

To look for an alarm recording by viewing the first 5 seconds of each alarm recording.

- 1 Press the **SEARCH** button twice during stop mode.
  - o "AL SCAN" will be displayed on screen.
- 2 Press the **FF** (or **REW**) button.
  - o The unit will advance (or rewind) the tape at high speed and playback the first 5 seconds of every alarm recording.
  - o To cancel the alarm scan mode, press the **STOP** button.
- 3 While the desired recording is being played back, press the **PLAY** button.
  - o Playback starts and alarm scan mode is canceled.

### NOTES:

- If the end of the tape is reached during a scan, the tape will rewind and stop. If the beginning of the tape is reached, it will stop.
- This function does not operate when a warning display appears on the digital display.

# SERIES RECORDING

Using 2 VCRs or more, the series recording function lets you switch recording from one unit to the next (only with VCRs of the same model as this one).

## Series Recording Setup

- Connect 2 VCRs or more as illustrated below.

- 1 Set the following items as indicated.

Item	VCR No.1	VCR No.2 and on
Cassette tape	Loaded	Loaded
Operation mode	Stop	Stop
"TAPE END MODE"(in (GENERAL SET) menu)	REW, STOP or EJECT	REW, STOP or EJECT
"SERIES REC" (in (ALARM/SERIES REC SET) menu)	Y (YES)	Y (YES)
Security lock	Canceled	Set

- 2 Press the **REC** button on VCR No.1.

◦ Recording will start in series recording mode.

- 3 Set the security lock on VCR No.1.

## Operation

The output signal at the **SERIES OUT** terminal will be present either at the point when the counter reading is 8:00:00 or when VCR No. 1 reaches the end of the tape, whichever is first.

When this signal is received by VCR No. 2, it will start recording.

When the tape end is reached, operation is then carried out according to the "TAPE END MODE" setting in the (GENERAL SET) menu.

## NOTES:

- When using tapes that are based on the VHS standard, a single tape can be used to record 8:00:00 or more based on the counter setting.
- If "SERIES REC" is set to "N" in the (ALARM/SERIES REC SET) menu, series recording will not be possible.
- The counter must start from the beginning of tape.
- Even if "OFF" is displayed, series recording will be conducted if there is an input at the **SERIES IN** terminal.

## Loop recording

- Connect the output from the **SERIES OUT** terminal of the last VCR to the **SERIES IN** terminal of the first VCR.
- The "TAPE END MODE" in (GENERAL SET) menu should be set to "REW" for all units without fail.
- In loop recording mode, the tape will be re-recorded over. If you need to keep the recorded information, please eject the tape after recording is complete and insert a new tape.

## Connection

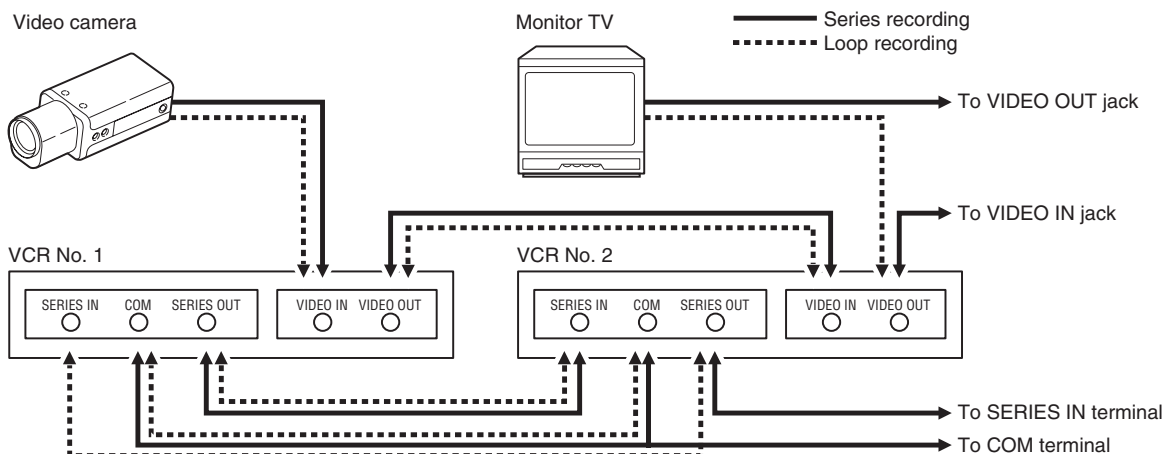

# PLAYBACK

## Normal Playback

- 1 Turn on the power to the VCR and TV monitor.
- 2 Load the video cassette tape.
- 3 Press the **PLAY** button.
  - *Playback starts.*
  - *If necessary, adjust the tracking to eliminate the noise from the picture.*
  - *If the image is unstable (rolling vertically), adjust the vertical lock control to correct.*
- 4 To stop playback, press the **STOP** button.
  - *To advance (or rewind) the tape, press the **FF** (or **REW**) button.*

### NOTE:

- A tape recorded on a video cassette recorder produced by another manufacturer may not play back with the same degree of clarity on this unit.

## Tracking Control

If there is noise in the image during playback,

- 1 While looking at the playback picture, press the **TRACKING+** button repeatedly to minimize the noise.
- 2 If it cannot be minimized, press the **TRACKING-** button repeatedly.

### NOTE:

- This function does not operate when a warning display appears on the digital display.

## Vertical Lock Control

During still image mode,

- 1 Press the **TRACKING+** button repeatedly to reduce the vertical rolling of the image.
- 2 If it cannot be corrected, press the **TRACKING-** button repeatedly.

### NOTE:

- This function does not operate when a warning display appears on the digital display.

## Picture Search (Forward and Reverse)

- 1 Press the **FF** (or **REW**) button, during normal playback.
  - *The image can be seen while the tape is advanced (or rewound) at high speed.*
- 2 To return to normal playback, press the **PLAY** button.

### NOTES:

- During picture search, noise (horizontal bars) will appear in the picture.
- The sound is muted.

## Still Image

- 1 Press the **STILL/PAUSE** button, during normal playback.
  - *A still image can be viewed.*
- 2 To return to normal playback, press the **PLAY** button.

### NOTES:

- If still mode continues for 5 minutes or more, the VCR will go into stop mode to avoid damaging the tape.
- If the image is unstable (rolling vertically), adjust the vertical lock control to correct.
- The sound is muted.

## Field Advance (Forward and Reverse)

- 1 Press the **FF** (or **REW**) button, during still image mode.
  - *The still image is advanced (or rewound) of one image (field).*
- 2 To return to normal playback, press the **PLAY** button.

### NOTES:

- During reverse field advance, noise will appear in the picture.
- If field advance mode continues for 5 minutes or more, the VCR will switch to stop mode to avoid damaging the tape.
- The sound is muted.

# DAY/TIME SEARCH

## Day/Time Search

This searches for a specified day/time for still images to be played back.

- ❶ Press the **SEARCH** button three times during stop mode.
  - “T/D SEARCH 01 00:00” will be displayed on screen.
- ❷ Press the ▼ (or ▲) button to set the desired day, then press the **ENTER** button.
- ❸ Press the ▼ (or ▲) button to set the desired hour, then press the **ENTER** button.
- ❹ Press the ▼ (or ▲) button to set the desired minutes.
  - The setting can be made in 10 minutes increments only.
- ❺ Press the **FF** (or **REW**) button.
  - The desired day/time is searched and a still image of the recording will appear on-screen.
- ❻ Press the **PLAY** button.
  - Playback will start.

## NOTES:

- If the end of the tape is reached during a search, the tape will rewind and stop. If the beginning of the tape is reached, it will stop.
- The alarm and day/time data are recorded on the tape in a similar format. If they overlap, the alarm data will have the priority. Therefore, when searching for a day/time when an alarm recording was done, the day/time search will not stop at the desired location. In such a case, use alarm scan to find the desired recording location.
- The day/time search function may not operate correctly if searching for a timer recording time or if the clock on the recording VCR has been adjusted using the **CLOCK ADJUSTMENT** function.
- If a recording on a tape extends for over a one month period, the same day may be present twice on the tape. If such a day is searched, since there is no month search setting, the desired day may not be found.
- This function does not operate when a warning display appears on the digital display.

# SECURITY LOCK

The security lock function is designed to prevent accidental stopping of recording if the **STOP** button is pressed inadvertently.

- ❶ While holding the **SHIFT** → button, press the ▼ button.
    - “**!**” appears on the digital display.
- To cancel the security lock, while holding the **SHIFT** → button, press the ▼ button, “**!**” will be erased from the digital display.

## NOTES:

- While the security lock is engaged all commands, except the one to cancel the security lock, are disabled.
- The security lock cannot be engaged while a menu is displayed.
- The security lock will be cancelled by pressing the **ALL RESET** button.

# CLOCK ADJUSTMENT

The time for the second and subsequent VCRs can be set to the same time as the first VCR.

A signal from a separate device can also be used to set the time for the second and subsequent VCRs to the same time as the first VCR. When using the signal from a separate device to set the time, input a 0 V signal to the **CLOCK IN** terminal of the first VCR for 100 ms or longer.

- ❶ Press the **MENU** button to display the MAIN MENU.
- ❷ Press the ▼ (or ▲) button to select the “3.GENERAL SET” line, then press the **ENTER** button.
- ❸ Press the ▼ (or ▲) button until the “CLOCK ADJUST” setting is highlighted, then press the **ENTER** button.
- ❹ Press the ▼ (or ▲) button to set the hour at which the adjustment will be conducted, then press the **ENTER** button.

## NOTE:

- The clock adjustment cannot be set to “00:00”.

## Example

<GENERAL SET>	
TAPE IN MODE	STOP
TAPE END MODE	REW
CLOCK ADJUST	03:00
THREAD CHECK	N
VIDEO LOSS	N
REMOTE	MENU
VIDEO	COLOR

- ❺ Press the **MENU EXIT** button.

The setting procedure on the first VCR is now completed.

- ❻ Repeat the procedure for all the other VCRs, setting “CLOCK ADJUST” (to the same time as set on the first VCR).

## NOTE:

- This function will not operate on the day the daylight saving/standard time is changed.

## Connection

# SETTING THE CASSETTE EJECT MODE

## Cassette Eject Setup

When using two or more VCRs, the cassette tapes of all the VCRs or some of the VCRs can be ejected at the same time.

- 1 Press the **MENU** button to display the MAIN MENU.
- 2 Press the ▼ (or ▲) button to select the “4.WARNING OUT/EJECT SET” line, then press the **ENTER** button.

○ The (WARNING OUT/EJECT SET) menu appears.

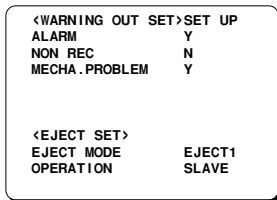

- 3 Press the ▼ (or ▲) button until the “EJECT MODE” setting is highlighted, then press the **ENTER** button.
- 4 Press the ▼ (or ▲) button to select the desired cassette eject mode, then press the **ENTER** button.

EJECT1 . . . . The cassette is ejected only if the VCR is not in recording or recording pause mode.

EJECT2 . . . . The cassette is ejected only if the VCR is in stop mode.

- 5 Press the ▼ (or ▲) button until the “OPERATION” setting is highlighted, then press the **ENTER** button.
- 6 Press the ▼ (or ▲) button to select the desired operation, then press the **ENTER** button.

SLAVE . . . . The function is restricted to only the VCR being operated.

MASTER . . . The function is applied to the VCR being operated and all VCRs that are connected after it.

- 7 Press the **MENU EXIT** button.

### NOTE:

- The **EJECT** button will not be operative during recording mode.

## Connection

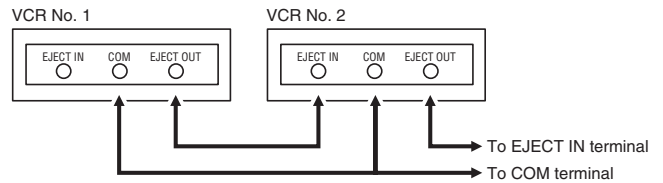

### EJECT IN terminal

- Depending on the “EJECT MODE” setting in the (WARNING OUT/EJECT SET) menu (see “Cassette Eject Setup”), the cassette loaded into the VCR can be ejected when there is input to this terminal.

### EJECT OUT terminal

- A signal is output from this terminal when the **EJECT** button is pressed (if the VCR is set up as the “MASTER” VCR; see step 6 under “Cassette Eject Setup”) or when there is input (a trigger) at the **EJECT IN** terminal, even if the security lock is set or a cassette is not loaded.

# CHECKING POWER FAILURE, FAILURE DUE TO CONDENSATION AND USAGE DURATION

- ① Press the **MENU** button to display the MAIN MENU.
- ② Press the ▼ (or ▲) button to select the “7.OTHERS” line, then press the **ENTER** button.
  - The (OTHERS) menu appears.

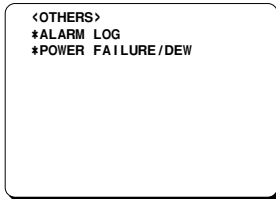

- ③ Press the ▼ (or ▲) button to select the “POWER FAILURE/DEW” line, then press the **ENTER** button.
  - The (POWER FAILURE/DEW/USED TIME) menu appears.

### Example

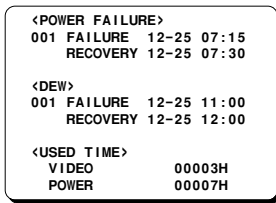

POWER FAILURE . . . . . The number of power failures, and the date and time of the most recent power failure and recovery are displayed.

DEW. . . . . The number of failures due to condensation, and the date and time of the most recent failure and recovery are displayed.

USED TIME . . . . . The video heads usage duration and the power on duration are displayed.

- ④ Press the **MENU EXIT** button.

### NOTE:

- If the **MENU RESET** button is pressed while the “POWER FAILURE” and “DEW” data is displayed, the data is erased. The “USED TIME” data cannot be reset. “P” will be erased from the digital display.



# OUTPUT TERMINALS

## TAPE END (SERIES) OUT Terminal

- During recording, when the end of the tape is reached or when the tape counter reading indicates 8 hours, the output becomes 0V (Low). During autorepeat recording, the output becomes 0 V (Low) for about 2 seconds only.
- To reset the output, press the **STOP** or **EJECT** button.

## TAPE END OUT Terminal Output Setting

- 1 Press the **MENU** button to display the MAIN MENU.
- 2 Press the ▼ (or ▲) button to select the "5.ALARM/SERIES REC SET" line, then press the **ENTER** button.
  - *The (ALARM/SERIES REC SET) menu appears.*

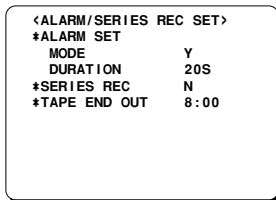

- 3 Press the ▼ (or ▲) button until the "TAPE END OUT" setting is highlighted, then press the **ENTER** button.
- 4 Press the ▼ (or ▲) button to select the desired mode, then press the **ENTER** button.
  - 8:00 . . . . . The output becomes 0 V (Low) when the tape counter reaches "8:00:00" and/or when the tape reaches the end.
  - END . . . . . The output becomes 0 V (Low) when the tape reaches the end.

## NOTES:

- If the "SERIES REC" is set to "Y" in the (ALARM/SERIES REC SET) menu, the output becomes 0 V (Low) for about 2 seconds when the counter reaches "8:00:00", even if the "TAPE END OUT" is set to "END".
- If the "SERIES REC" is set to "Y" in the (ALARM/SERIES REC SET) menu, the output becomes 0 V (Low) until 5 minutes have passed after the tape reaches the end.

- 5 Press the **MENU EXIT** button.

## COM Terminal

- Common GND (ground) terminal when connecting other terminals to external devices.

# OUTPUT TERMINALS

## SW OUT Terminal

When recording, a pulse signal is output at the **SW OUT** terminal.

This terminal is usually connected to the switch input (SW IN) of devices like a camera switcher unit, or a quad compressor.

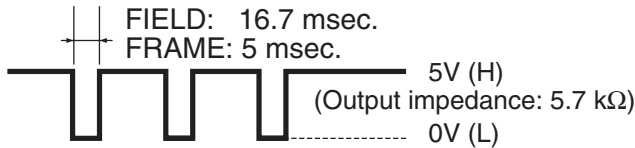

## SW OUT Terminal Output Setting

- 1 Press the **MENU** button to display the MAIN MENU.
- 2 Press the ▼ (or ▲) button to select the “2.DISPLAY/SW OUT SET” line, then press the **ENTER** button.
  - o *The (DISPLAY/SW OUT SET) menu appears.*

<DISPLAY SET>	SET UP
DATE	Y
TIME	Y
ALARM COUNT	Y
<SW OUT SET>	FIELD
TIMING	1
FIELD	Y
OUTPUT	Y

- 3 Press the ▼ (or ▲) button until the “TIMING” setting is highlighted, then press the **ENTER** button.
- 4 Press the ▼ (or ▲) button to select the desired output timing, then press the **ENTER** button.
  - FIELD. . . . . 1 pulse is output after each set number of fields.
  - FRAME . . . . . 1 pulse is output after each set number of frames.
- 5 Press the **ENTER** button.
- 6 Press the ▼ (or ▲) button to select the desired pulse signal interval (1, 2, 3, 4, 5, 10, 30 or 60), then press the **ENTER** button.
  - If “TIMING” is set to FRAME (see step 4), “FRAME” will be indicated instead of “FIELD”.
- 7 Press the **ENTER** button.

- 8 Press the ▼ (or ▲) button to select the desired “OUTPUT” mode, then press the **ENTER** button.
  - Y. . . . . When recording, a pulse signal is output.
  - N . . . . . When recording, a pulse signal is not output.
- 9 Press the **MENU EXIT** button.

# OUTPUT TERMINALS

## WARNING OUT Terminal

- The **WARNING OUT** terminal output becomes 0 V (Low) in accordance with the (WARNING OUT/EJECT SET) menu.

### WARNING OUT Terminal Output Setting

- ① Press the **MENU** button to display the MAIN MENU.
- ② Press the ▼ (or ▲) button to select the “4.WARNING OUT/EJECT SET” line, then press the **ENTER** button.
  - The (WARNING OUT/EJECT SET) menu appears.

<WARNING OUT SET>SET UP	
ALARM	Y
NON REC	N
MECHA. PROBLEM	Y
VIDEO LOSS	Y
<EJECT SET>	
EJECT MODE	EJECT1
OPERATION	SLAVE

- ③ Press the **ENTER** button.
- ④ Press the ▼ (or ▲) button to select the desired mode, then press the **ENTER** button.
  - SET UP . . . . . Set each item
  - ALL Y . . . . . To set all items to “Y”
  - ALL N . . . . . To set all items to “N”
  - If using the “SET UP” setting, continue with steps ⑤ to ⑦.
- ⑤ Press the ▼ (or ▲) button until the item for warning output is highlighted, then press the **ENTER** button.
- ⑥ Press the ▼ (or ▲) button to set “Y” (warning is given) or “N” (warning is not given), then press the **ENTER** button.

- ALARM. . . . . The output becomes 0 V and “A” appears on the digital display during alarm recording
- NON REC . . . . . The output becomes 0 V and “N” appears on the digital display if the VCR enters a mode other than recording (i.e. recording pause, stop mode, etc.) during recording
- MECHA. PROBLEM . . . The output becomes 0 V and “M” appears on the digital display when the tape stops or other problem with the internal mechanism

VIDEO LOSS . . . . . The output becomes 0 V and “V” appears on the digital display when there is no video signal

- ⑦ Repeat steps ⑤ and ⑥ when setting other items.
- ⑧ When finished, press the **MENU EXIT** button.

### NOTES:

- The “VIDEO LOSS” line does not appear if “VIDEO LOSS” is set to “N” in the (GENERAL SET) menu.
- Displays on the digital display take precedence over other displays.
- Canceling warning displays and output.
  - Press the **STOP** button once.
  - The warning display disappears from the digital display.
  - Press the **STOP** button once more.
  - If “MECHA. PROBLEM” warning is being output, then output stops.
- If the “NON REC”, “VIDEO LOSS” or “ALARM” warning is being output, the condition immediately before the warning output is restored and the output stops.
- If the system has shut down because of a “MECHA. PROBLEM” warning, the output is canceled when the **ALL RESET** button is pressed.

# OUTPUT TERMINALS

## REMOTE Jack

Remote control of the VCR is possible by connecting a remote controller with a circuit such as indicated below, to the **REMOTE** jack.

### NOTES:

- Use a 3.5 mm mini-jack type plug.
- The connection should be done using a shielded cable no more than 5 meters long.
- The functions not available on the VCR will not operate.
- You can use a VA-RMN01 Remote Control Unit (sold separately) to control the VCR remotely. The functions not available on the VCR will not operate.

Remote control circuit

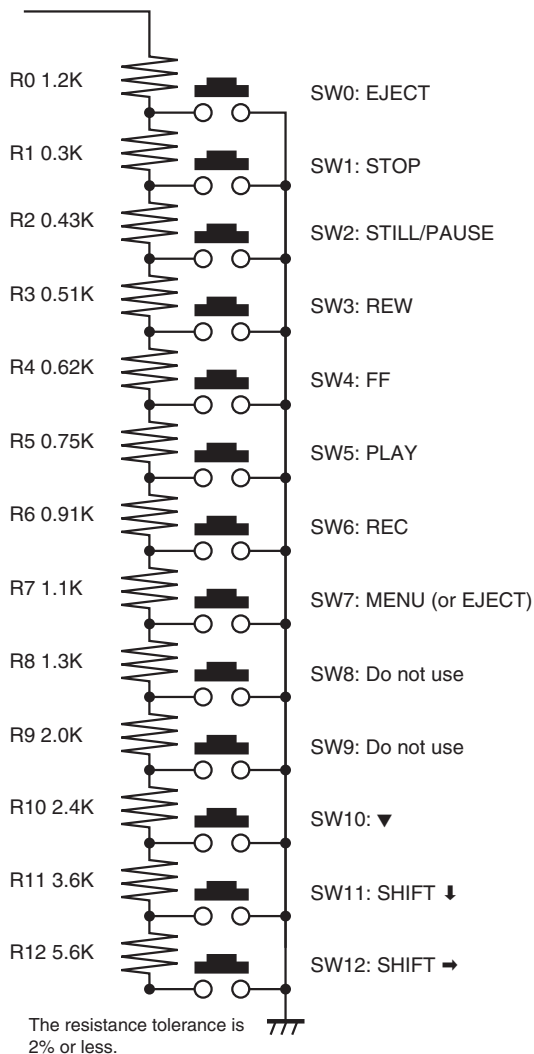

## Remote control setting

The remote control switch 7 (see illustration at left) can be set to either eject the tape or access the menus.

- 1 Press the **MENU** button to display the MAIN MENU.
- 2 Press the ▼ (or ▲) button to select the “3.GENERAL SET” line, then press the **ENTER** button.
  - The (GENERAL SET) menu appears.

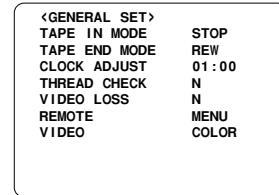

- 3 Press the ▼ (or ▲) button until the “REMOTE” setting is highlighted, then press the **ENTER** button.
- 4 Press the ▼ (or ▲) button to select the desired switch mode, then press the **ENTER** button.
  - MENU . . . . . Switch operates as a **MENU** button
  - EJECT . . . . . Switch operates as an **EJECT** button
- 5 Press the **MENU EXIT** button.

# MAINTENANCE

## Daily Inspection

The following daily inspections are recommended in order to assure long-term and trouble-free operation of the unit.

The daily inspections are particularly important if using autorepeat recording.

## Inspection Procedure

- ❶ Turn on the power to the VCR, camera, TV monitor and other connected devices.
- ❷ Check that the image received on the TV monitor is correct.
- ❸ Check that the on-screen display of the date and time is correct.
- ❹ To check the recording condition of the previous day, rewind the recorded tape a few seconds.
- ❺ Press the **PLAY** button and check that the playback image is correct.
- ❻ Check that the recorded date and time are correct.

### NOTES:

- If the security lock is engaged, it has to be released before proceeding to the inspection.
- If any problem is discovered during the inspection, unplug the power cord then consult your dealer.

## Periodic Inspection

Periodic inspection and maintenance should be referred to your dealer.

If there is noise in the playback picture, and it cannot be corrected using the tracking control, it may indicate that the video heads need cleaning.

Soiling is unlikely, thanks to the automatic head cleaning function, but due to factors such as the use of poor quality tape and the usage environment the heads could become dirty in a short time.

The video heads should be inspected every 1,000 hours of use to determine if they need to be replaced.

The video heads usage can be checked using the (POWER FAILURE/DEW/USED TIME) menu.

## Cabinet Cleaning

Clean the outside of the cabinet with a clean, soft cloth, moistened with lukewarm water and wrung dry.

DO NOT USE SOLVENTS OR OTHER TYPES OF CLEANERS. THESE CHEMICALS CAN CRACK OR DISCOLOR THE CABINET.

## About the Backup Battery

The date and time settings are maintained for up to 30 days by a rechargeable lithium battery that is fully charged after the VCR has been connected to a power source for 48 hours or more.

Depending on the battery usage it may become necessary to change it. For replacement and disposal of the old battery, please contact your dealer.

After the battery has been replaced, press the **ALL RESET** button, then enter all the time, date, etc. settings as required.

## Automatic Head Cleaning Function

- Whenever a video cassette is loaded or ejected, the video heads are automatically cleaned.
- During autorepeat recording, the video heads are automatically cleaned when the tape reaches the end.

# MAINTENANCE

## Maintaining and Checking The Mechanism

To maintain the VCR functions and features working properly, and to avoid damages or dirt on the tape, it is recommended to follow the maintenance points and periodicity indicated below.

For detailed information, please contact your dealer.

### Maintenance Table

○ : Cleaning    ⊙ : Confirmation    △ : Lubrication    □ : Change

	PARTS	2000H	4000H	6000H	8000H	NOTES
Tape Path System	ASSY, BRAKE BAND	⊙	□	⊙	□	
	ASSY, LEVER BT (tape guide)	○	○	○	○	
	FULL ERASE HEAD	○	○	○	□	
	ASSY, ROLLER CLEANER	⊙	□	⊙	□	
	ASSY, GUIDE ROLLER	○	○	○	○	
	ASSY, MOUNTING INCLNE S	○	○	○	□	
	ASSY, MOUNTING INCLNE T	○	○	○	□	
	ACE HEAD	○	○	○	□	
	ASSY, LEVER PINCH ROLLER	○	□	○	□	
	MOUNTING, LIFT PINCH				□	
	CAM, LIFT PINCH				□	
	GEAR, CAM PINCH				□	
	EARTH CHIP CYLINDER				□	
	COMPL, CYLINDER	○	○(□)	○	○(□)	
ASSY, CYLINDER UPPER	○(□)	○(□)	○(□)	○(□)		
Reel Drive System	ASSY, REEL SUPPLY	○△	○△	○△	○△	
	ASSY, REEL TAKEUP	○△	○△	○△	○△	
	GEAR, REEL S	△	△	△	△	
	GEAR, REEL T	△	△	△	△	
	PULLEY, REEL	△	△	△	△	
	SPECIAL, WASHER 2.4 X 6 X 0.25		⊙		⊙	
	COMPL, MOUNTING CLUTCH	△	□	△	□	
	BELT, REEL	⊙	□		□	
	MOTOR, CAPSTAN	○	⊙(□)	⊙(□)	□	
ASSY, GEAR FRICTION	△	△□	△	△□		
Brake	ASSY, BRAKE S	⊙	⊙	⊙	⊙	
	ASSY, BRAKE T	⊙	⊙	⊙	⊙	
	ASSY, BRAKE CAPSTAN	⊙	⊙	⊙	⊙	
	ASSY, BRAKE SOFT T		⊙		□	
Loading Drive System	ASSY, LOADING MOTOR		⊙		□	
	DAMPER				□	
	COMPL, GEAR WORM		⊙		□	
	CAM, MAIN				□	
	SPECIAL WASHER 3.6 X 0.5		⊙		□	
	GEAR, WHEEL 1				□	
	GEAR, WHEEL 2		⊙		□	
	GEAR RELAY PINCH OPT				□	
	SLIDE, CRECENT		⊙		□	
	GEAR, LOAD S		⊙		□	
	GEAR, RACK FRONT		⊙		□	
	GEAR, RACK START		⊙		□	
GEAR, PINON		⊙		□		
Performance Check	BACK TENSION TORQUE	⊙	⊙	⊙	⊙	PB BACK TENSION TORQUE 25~50g·cm
	FWD, REW TORQUE	⊙	⊙	⊙	⊙	FWD, REW TORQUE ≥ 600g·cm
	PLAY TORQUE	⊙	⊙	⊙	⊙	PLAY 55 ~ 110g·cm
	REV TORQUE	⊙	⊙	⊙	⊙	REV 100 ~ 210g·cm

### NOTES:

- This table shows the maintenance for up to 8000 hours. After this, repeat from the start or the table.
- For places with symbols such as ⊙ (□) and ○ (□), carry out checking and cleaning, and replace if necessary.
- This periodic maintenance check table changes considerably according to the using conditions and environment.
- Refer to the (POWER FAILURE/DEW/USED TIME) menu for the length of time the unit has been used.
- As the life of parts may be shortened if foreign particles and dusts remain accumulated on the tape guides and rotating and contacting portions, clean if dirty.
- Dusts and other foreign particles on the tape guides may also shorten the tape life and lower picture quality, therefore clean thoroughly.

# TROUBLESHOOTING GUIDE

If the unit does not operate normally when you follow the instructions indicated in the manual, please refer to the table below.

SYMPTOM	POSSIBLE CAUSE	CORRECTIVE ACTION
No power	The power cord is not connected	Connect the power cord
No image displayed on the TV monitor	The connections are not correct	Check that all connections are correct
	The power to the camera and/or TV monitor is not turned on	Turn all connected devices power on
The buttons do not respond	A cassette tape is not loaded	Load a cassette
	All functions are suspended due to condensation	Wait for the “ <i>ddd</i> ” indicator to go off
	Alarm recording	Wait for the alarm recording to end
	Unit in menu mode	Press the <b>MENU EXIT</b> button.
	The security lock is engaged	Cancel the security lock
Recording is not possible (the tape is ejected)	The loaded cassette has no erasure-prevention tab	Load a cassette tape with an erasure-prevention tab or cover the tab hole with adhesive tape
Recording is not possible (Tape rewinds)	“Y” is selected for the tape management	Normally. Refer to “TAPE MANAGEMENT” on page 16.
Autorepeat recording is not possible	“AL” appears on the digital display	Display (ALARM LOG) menu, then press the <b>MENU RESET</b> button to turn off the “AL” indicator
Alarm recording is not possible	“OFF” appears on the digital display	Press the <b>EJECT, STOP, FF, REW</b> or <b>PLAY</b> button to turn the indicator off
Noise in the playback picture	The video heads need cleaning	Clean the video heads
The date and time are not recorded	Display mode not set.	Set the <b>ON SCREEN</b> switch to the “ON” position.
The cassette tape cannot be ejected	Problem with the system	Unplug the power cord then plug it back in
The cassette is ejected a few seconds after it has been inserted	The tape is not threaded correctly	Try inserting the cassette one more time or using a new cassette. If it is ejected again, please consult your dealer.

## System Down

If the unit does not function at all, try the following.

- ❶ Unplug the power cord then plug it back in.
- ❷ Reset the memory. (Press the **ALL RESET** button. Under normal conditions, do not touch the **ALL RESET** button.)  
The time and date will be reset, and the security lock will be canceled.
- ❸ If the problem is not corrected after performing steps ❶ and ❷ a few times, consult your dealer.

# SPECIFICATIONS

## General Specifications

Video head system

Dual-azimuth 4-head rotating helical scanning system:

Dual azimuth 2-head for record and standard playback



# SANYO INDUSTRIAL VCR WARRANTY

## OBLIGATIONS

In order to obtain warranty service, the product must be delivered to and picked up from an Authorized Sanyo Service Center at the user's expense, unless specifically stated otherwise in this warranty. The names and addresses of Authorized Sanyo Service Centers may be obtained by calling the toll-free number listed below.

For product operation, authorized service center referral, service assistance or problem resolution, call

**CUSTOMER INFORMATION 1-800-421-5013**  
**Weekdays 8:30 AM –5:00 PM Pacific Time**

For accessories and/or parts, call

**PARTS ORDER INFORMATION 1-800-726-9662**  
**Weekdays 8:30 AM –5:00 PM Pacific Time**

THIS WARRANTY IS VALID ONLY ON SANYO PRODUCTS PURCHASED OR RENTED IN THE UNITED STATES OF AMERICA, EXCLUDING ALL U.S. TERRITORIES AND PROTECTORATES. THIS WARRANTY APPLIES ONLY TO THE ORIGINAL RETAIL PURCHASER OR END-USER. THE ORIGINAL DATED BILL OF SALE, SALES SLIP OR RENTAL AGREEMENT MUST BE SUBMITTED TO THE AUTHORIZED SANYO SERVICE CENTER AT THE TIME WARRANTY SERVICE IS REQUESTED.

Subject to the OBLIGATIONS above and EXCLUSIONS below, SANYO Fisher Company warrants this SANYO product against defects in materials and workmanship for the periods specified below. SFC will repair or replace (at its option) the product and any of its parts which fail to conform to this warranty. The warranty period commences on the date the product was first purchased or rented at retail.

LABOR	PARTS	VIDEO HEADS
1 YEAR	1 YEAR	90 DAYS

## EXCLUSIONS

This warranty does not cover (A) the adjustment of customer-operated controls as explained in the appropriate model's instruction manual, or (B) the repair of any product whose serial number has been altered, defaced or removed.

This warranty shall not apply to the cabinet or cosmetic parts, batteries or routine maintenance.

This warranty does not apply to uncrating, setup, installation, removal of the product for repair or reinstallation of the product after repair.

This warranty does not apply to repairs or replacements necessitated by any cause beyond the control of SFC including, but not limited to, any malfunction, defect or failure caused by or resulting from unauthorized service or parts, improper maintenance, operation contrary to furnished instructions, shipping or transit accidents, modification or repair by the user, abuse, misuse, neglect, accident, incorrect power line voltage, fire, flood or other Acts of God, or normal wear and tear.

The foregoing is in lieu of all other expressed warranties and SFC does not assume or authorize any party to assume for it any other obligation or liability.

SFC DISCLAIMS ALL OTHER WARRANTIES EXPRESS OR IMPLIED, WITH REGARD TO THIS PRODUCT (INCLUDING THE WARRANTIES OF MERCHANTABILITY AND FITNESS). IN NO EVENT SHALL SFC BE LIABLE FOR ANY SPECIAL, INCIDENTAL OR CONSEQUENTIAL DAMAGES ARISING FROM THE OWNERSHIP OR USE OF THIS PRODUCT OR FOR ANY DELAY IN THE PERFORMANCE OF ITS OBLIGATIONS UNDER THIS WARRANTY DUE TO CAUSES BEYOND ITS CONTROL. SFC'S LIABILITY FOR ANY AND ALL LOSSES AND DAMAGES RESULTING FROM ANY CAUSE WHATSOEVER, ARISING OUT OF OR IN CONNECTION WITH THE SALE, USE OR OWNERSHIP OF THIS PRODUCT INCLUDING WARRANTOR'S NEGLIGENCE, ALLEGED DAMAGED OR DEFECTIVE GOODS, WHETHER SUCH DEFECTS ARE DISCOVERABLE OR LATENT, SHALL IN NO EVENT EXCEED THE PURCHASE PRICE OF THE PRODUCT.

## ATTENTION

For your protection in the event of theft or loss of this product, please fill in the information below for you own personal records.

**Model No.** \_\_\_\_\_ **Serial No.** \_\_\_\_\_  
(Located on back or bottom side of unit.)

**Date of Purchase** \_\_\_\_\_ **Purchase Price** \_\_\_\_\_

**Where Purchased** \_\_\_\_\_

